

# WEED EATER

® Trademark

ENGLISH



Please do not return unit to retailer.  
Por favor, no devuelva el aparato al lugar de compra.  
Veuillez ne pas retourner l'outil au détaillant.

**1-800-554-6723**

[www.weedeater.com](http://www.weedeater.com)

## Operator's Manual Manual del Operador Manuel de L'utilisateur

**XT 200/XT 25  
FeatherLite™ Series  
Wild Thing™ WT21**

ESPAÑOL



### **WARNING:**

Read and follow all Safety Rules and Operating Instructions before using this product. Failure to do so can result in serious injury.

### **ADVERTENCIA:**

Lea el manual del operador y siga todas las advertencias e instrucciones de seguridad. El no hacerlo puede resultar en lesiones graves.

### **AVERTISSEMENT:**

Lire le manuel de l'utilisateur et bien respecter tous les avertissements et toutes les instructions de sécurité. Tout défaut de le faire pourrait entraîner des blessures graves.

FRANÇAIS

Frigidaire Home Products, Augusta, GA 30907  
WCI Outdoor Products, Inc.

530087310 2/16/00

## SAFETY RULES

**WARNING:** When using gardening appliances, basic safety precautions should always be followed to reduce the risk of fire and serious injury. Read and follow all instructions.

*This power unit can be dangerous!* Operator is responsible for following unit and manual instructions and warnings. Read entire Operator's Manual before using unit! Be thoroughly familiar with the controls and the proper use of the unit. Restrict the use of this unit to persons who read, understand, and follow unit and manual instructions and warnings. Never allow children to operate this unit.



OPERATORS  
MANUAL



SAFETY INFORMATION  
ON THE UNIT

**DANGER:** Never use blade, wire or flailing devices. This unit is designed for line trimmer use only. Use of any other accessories or attachments will increase the risk of injury.



**WARNING:** Trimmer line throws objects violently. You and others can be blinded/injured. Wear safety glasses and leg protection. Keep body parts clear of rotating line.

Safety glasses or similar eye protection

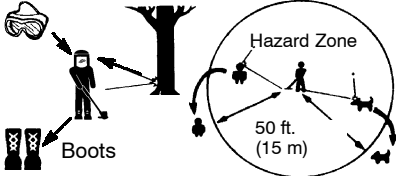

Keep children, bystanders, and animals 50 feet (15 meters) away. If approached, stop unit immediately.

If situations occur which are not covered in this manual, use care and good judgment. If you need assistance, contact your Authorized Service Dealer or call 1-800-554-6723.

### OPERATOR SAFETY

- Always wear safety eye protection.
- Always wear long pants, long sleeves, boots, and gloves. Wearing safety leg

guards is recommended. Do not go barefoot or wear sandals. Stay clear of spinning line.

- Secure hair above shoulder length. Secure or remove loose clothing or clothing with loosely hanging ties, straps, tassels, etc. They can be caught in moving parts.
- Do not operate this unit when you are tired, ill, or under the influence of alcohol, drugs, or medication.
- Wear hearing protection if you use this unit for more than 1 1/2 hours per day.
- Never start or run inside a closed room or building. Breathing exhaust fumes can kill.
- Keep handles free of oil and fuel.

### UNIT/MAINTENANCE SAFETY

- Disconnect the spark plug before performing maintenance except carburetor adjustments.
- Look for and replace damaged or loose parts before each use. Look for and repair fuel leaks before use. Keep in good working condition.
- Replace trimmer head parts that are chipped, cracked, broken, or damaged in any other way before using the unit.
- Make sure unit is assembled correctly as shown in this manual.
- Make carburetor adjustments with lower end supported to prevent line from contacting any object.
- Keep others away when making carburetor adjustments.
- Use only recommended WEED EATER accessories and replacement parts.

### FUEL SAFETY

- Mix and pour fuel outdoors.
- Keep away from sparks or flames.
- Use a container approved for fuel.
- Do not smoke or allow smoking near fuel or the unit.
- Wipe up all fuel spills.
- Move at least 10 feet (3 meters) away from fueling site before starting engine.
- Stop engine and allow to cool before removing fuel cap.

### CUTTING SAFETY

- Use only for trimming, mowing, and sweeping. Do not use for edging, pruning, or hedge trimming.
- Inspect the area before each use. Remove objects (rocks, broken glass, nails, wire, etc.) which can be thrown by or become entangled in line. Hard objects can damage trimmer head and be thrown causing serious injury.
- Keep firm footing and balance. Do not overreach.
- Keep all parts of your body away from spinning line and muffler. Keep engine below waist level. A hot muffler can cause serious burns.
- Cutting with the line on left side of the shield will throw debris away from the operator.

## TRANSPORTING AND STORAGE

- Allow the engine to cool; secure unit before storing or transporting in vehicle.
- Empty the fuel tank before storing or transporting the unit. Use up fuel left in the carburetor by starting the engine and letting it run until it stops.
- Store unit and fuel in an area where fuel vapors cannot reach sparks or open flames from water heaters, electric motors or switches, furnaces, etc.
- Store unit so line limiter cannot accidentally cause injury. Unit can be hung by the tube.
- Store the unit out of the reach of children.

If situations occur which are not covered in this manual, use care and good judgment. If you need assistance, call 1-800-554-6723.

**SPECIAL NOTICE:** This unit is not equipped with a temperature limiting muffler and spark arresting screen which meets the requirements of California Codes 4442 and 4443. All U.S. forest land and the states of California, Idaho, Maine, Minnesota, New Jersey, Oregon, and Washington require by law that many internal combustion engines to be equipped with a spark arrestor screen. If you operate in a locale where such regulations exist, you are legally responsible for installing and maintaining the operating condition of these parts. Failure to do so is a violation of the law. If a spark arrestor is required in your area, contact your Authorized Service Dealer for the proper kit.

**SPECIAL NOTICE:** Exposure to vibrations through prolonged use of gasoline powered hand tools could cause blood vessel or nerve damage in the fingers, hands, and joints of people prone to circulation disorders or abnormal swellings. Prolonged use in cold weather has been linked to blood vessel damage in otherwise healthy people. If symptoms occur such as numbness, pain, loss of strength, change in skin color or texture, or loss of feeling in the fingers, hands, or joints, discontinue the use of this tool and seek medical attention. An anti-vibration system does not guarantee the avoidance of these problems. Users who operate power tools on a continual and regular basis must monitor closely their physical condition and the condition of this tool.

## ASSEMBLY

**WARNING:** Make sure your unit is properly assembled and all fasteners are secure.

### ADJUST THE HANDLE

- Loosen wing nut on handle.
- Rotate handle to upright position and tighten in a comfortable position between

the trigger and the safety label on the tube. Tighten handle securely.

### ATTACH THE SHIELD

**WARNING:** The shield must be properly installed. The shield provides partial protection from the risk of thrown objects to the operator and others and is equipped with a line limiter which cuts excess line. The line limiter (on underside of shield) is sharp and can cut you.

Assemble your shield (Style A or Style B) as shown.

#### STYLE A

- Insert bracket into slot in shield. Tighten securely.

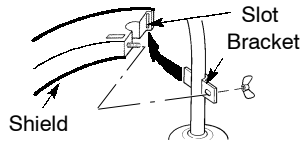

#### STYLE B

- Assemble parts as shown; Tighten securely.

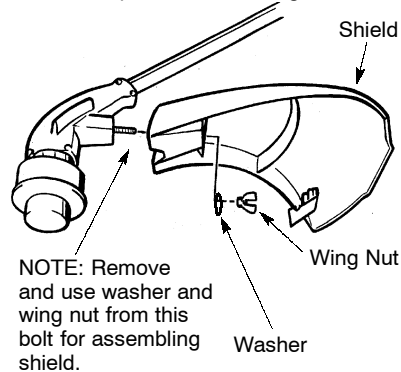

## FUEL YOUR UNIT

This engine is certified to operate on unleaded gasoline. Gasoline must be mixed with a good quality 2-cycle air-cooled engine oil designed to be mixed at a ratio of 40:1. Poulan/Weed Eater brand oil is recommended. (A 40:1 ratio is obtained by mixing 3.2 ounces of oil with 1 gallon of unleaded gasoline). When mixing fuel follow the instructions printed on the container. Always read and follow the safety rules under FUEL SAFETY.

## STARTING

### HOW TO STOP YOUR UNIT

Push and hold engine stop switch in the STOP or OFF position until the unit has fully stopped.

## HOW TO START YOUR UNIT

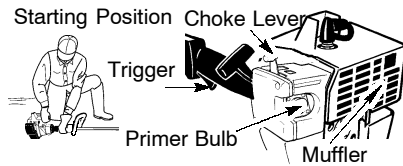

**WARNING:** The trimmer head will turn while starting the engine. A hot muffler can cause serious burns.

## COLD ENGINE STARTING OR STARTING AFTER REFUELING

- Set unit on a flat surface.
- Slowly press the primer bulb 6 times.
- Move choke lever to FULL CHOKE position.
- Squeeze the throttle trigger fully and hold through *all remaining steps*.
- Pull starter rope handle sharply 6 times.
- Move choke lever to HALF CHOKE position.
- Pull starter rope handle no more than 6 pulls, until engine runs.
- Allow engine to run 10 seconds, then move choke lever to OFF CHOKE position.

## RESTARTING A WARM ENGINE

- Move choke lever to OFF CHOKE position.
- Pull starter rope handle until engine runs.
- If engine does not start in 5 pulls, follow instructions in STARTING A COLD ENGINE.

## USING YOUR UNIT

For occasional use only.

## OPERATING POSITION

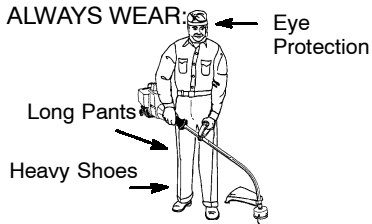

Cut from your right to your left.

## ADVANCING THE CUTTING LINE

Advance line by tapping the bottom of the cutting head lightly on the ground while engine is running at full speed. A metal blade attached to the shield will cut the line to the proper length.

## REPLACING THE LINE

- Remove spool by firmly pulling on tap button.
- Clean entire surface of hub and spool.
- Replace with pre-wound spool, or cut a length of 18 feet of .065" (1.6 mm) diameter Weed Eater® brand line. Never use wire, rope, string, etc., which can break off and become a dangerous missile.
- Insert one end of line about 1/2 inch (1 cm) into the small hole on the inside of the spool.
- Wind line evenly and tightly onto spool. Wind in the direction of the arrow on the spool.
- Push the line into the notch, leaving 3 to 5 inches (7 - 12 cm) unwound.
- Insert the line into the exit hole in the hub as shown in the illustration.
- Align the notch with the line exit hole.
- Push spool into hub until it snaps into place.
- Pull the line extending outside of the hub to release it from the notch.

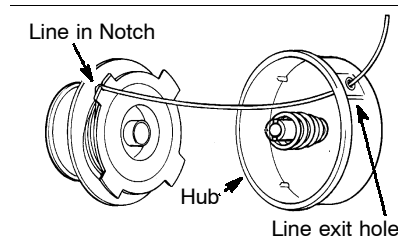
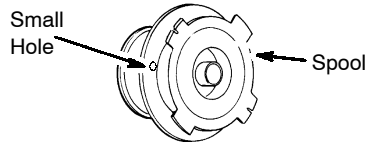

## SERVICE

We recommend all service and adjustments not listed in this manual be performed by an Authorized Service Dealer.

## CARBURETOR ADJUSTMENTS

Your carburetor is equipped with limiter caps. Adjusting the carburetor is a complicated task. We recommend that you take your unit to an Authorized Service Dealer. Damage will occur if you turn the needles beyond the limiter stops.

## IGNITION TIMING

The ignition timing is fixed, non-adjustable.

## SPARK PLUG

Replace the spark plug yearly using a Champion RCJ-8Y plug. Spark plug gap is .025".

## TROUBLESHOOTING

Engine will not start.

- Fuel tank empty.
- Engine flooded.
- Spark plug not firing.
- Fuel not reaching carburetor.
- Carburetor requires adjustment.

Engine will not idle properly.

- Carburetor requires adjustment.
- Throttle trigger screw too tight.

Engine will not accelerate, lacks power, or dies under a load

- Air filter dirty.
- Spark plug fouled.
- Carburetor requires adjustment.

Engine smokes excessively.

- Air filter dirty.
- Too much oil mixed with gasoline.
- Carburetor requires adjustment.

Line does not advance or breaks while cutting.

- Line improperly routed in head.
- Line improperly wound on spool.
- Line size incorrect

Line welds onto spool.

- Line size incorrect.
- Line improperly wound on spool.
- Crowding line on material being cut.

Line pulls back into head.

- Too little line outside of head.
- Line size incorrect

## NEED ASSISTANCE?

### Need Assistance?

Call 1-800-554-6723

### Need Service Part?

Contact your dealer.

## LIMITED WARRANTY

**FRIGIDAIRE HOME PRODUCTS, Div. WCI Outdoor Power Products, Inc.**, warrants to the original purchaser that each new **Weed Eater** brand gasoline tool or attachment is free from defects in material and workmanship and agrees to repair or replace under this warranty any defective gasoline product or attachment as follows from the original date of purchase

**2 YEARS** - Parts and Labor, when used for household purposes.

**60 DAYS** - Parts and Labor, when used for commercial, professional, or income producing purposes.

**30 DAYS** - Parts and Labor, if used for rental purposes.

This warranty is not transferable and does not cover damage or liability caused by improper handling, improper maintenance, or the use of accessories and/or attachments not specifically recommended by **FRIGIDAIRE HOME PRODUCTS** for this tool.

Additionally, this warranty does not cover tune-ups, spark plugs, filters, starter ropes, starter springs, cutting line, or rotating head parts that will wear and require replacement with reasonable use during the warranty period. This warranty does not cover predelivery setup or normal adjustments explained in the operator's manual.

**THIS WARRANTY GIVES YOU SPECIFIC LEGAL RIGHTS, AND YOU MAY HAVE OTHER RIGHTS WHICH VARY FROM STATE TO STATE.**

**NO CLAIMS FOR CONSEQUENTIAL OR OTHER DAMAGES WILL BE ALLOWED, AND THERE ARE NO OTHER EXPRESS WARRANTIES EXCEPT THOSE EXPRESSLY STIPULATED HEREIN.**

**SOME STATES DO NOT ALLOW LIMITATIONS ON HOW LONG AN IMPLIED WARRANTY LASTS OR THE EXCLUSION OR LIMITATIONS OF INCIDENTAL OR CONSEQUENTIAL DAMAGES, SO THE ABOVE LIMITATIONS OR EXCLUSION MAY NOT APPLY TO YOU.**

**FRIGIDAIRE HOME PRODUCTS'** policy is to continuously improve its products. Therefore, **FRIGIDAIRE HOME PRODUCTS** reserves the right to change, modify, or discontinue models, designs, specifications, and accessories of all products at any time without notice or obligation to any purchaser.

# U.S. EPA / ENVIRONMENT CANADA EMISSION CONTROL WARRANTY STATEMENT

**YOUR WARRANTY RIGHTS AND OBLIGATIONS:** The U. S. Environmental Protection Agency/Environment Canada and **POULAN/WEED EATER, DIVISION OF WCI OUTDOOR PRODUCTS** are pleased to explain the emissions control system warranty on your lawn and garden equipment engine. All new utility and lawn and garden equipment engines must be designed, built, and equipped to meet the stringent anti-smog standards. **POULAN/WEED EATER** must warrant the emission control system on your lawn and garden equipment engine for the periods of time listed below provided there has been no abuse, neglect, or improper maintenance of your lawn and garden equipment engine. Your emission control system includes parts such as the carburetor and the ignition system. Where a warrantable condition exists, **POULAN/WEED EATER** will repair your lawn and garden equipment engine at no cost to you. Expenses covered under warranty include diagnosis, parts and labor. **MANUFACTURER'S WARRANTY COVERAGE:** If any emissions related part on your engine (as listed under Emissions Control Warranty Parts List) is defective or a defect in the materials or workmanship of the engine causes the failure of such an emission related part, the part will be repaired or replaced by **POULAN/WEED EATER**. **OWNER'S WARRANTY RESPONSIBILITIES:** As the lawn and garden equipment engine owner, you are responsible for the performance of the required maintenance listed in your Owner's Manual. **POULAN/WEED EATER** recommends that you retain all receipts covering maintenance on your lawn and garden equipment engine, but **POULAN/WEED EATER** cannot deny warranty solely for the lack of receipts or for your failure to ensure the performance of all scheduled maintenance. As the lawn and garden equipment engine owner, you should be aware that **POULAN/WEED EATER** may deny you warranty coverage if your lawn and garden equipment engine or a part of it has failed due to abuse, neglect, improper maintenance, unapproved modifications, or the use of parts not made or approved by the original equipment manufacturer. You are responsible for presenting your lawn and garden equipment engine to a **POULAN/WEED EATER** authorized repair center as soon as a problem exists. Warranty repairs should be completed in a reasonable amount of time, not to exceed 30 days. If you have any questions regarding your warranty rights and responsibilities, you should contact your nearest authorized service center or call **POULAN/WEED EATER** at **1-800-554-6723**. **WARRANTY COMMENCEMENT DATE:** The warranty period begins on the date the lawn and garden

equipment engine is purchased. **LENGTH OF COVERAGE:** This warranty shall be for a period of two years from the initial date of purchase. **WHAT IS COVERED: REPAIR OR REPLACEMENT OF PARTS.** Repair or replacement of any warranted part will be performed at no charge to the owner at an approved **POULAN/WEED EATER** servicing center. If you have any questions regarding your warranty rights and responsibilities, you should contact your nearest authorized service center or call **POULAN/WEED EATER** at **1-800-554-6723**. **WARRANTY PERIOD:** Any warranted part which is not scheduled for replacement as required maintenance, or which is scheduled only for regular inspection to the effect of "repair or replace as necessary" shall be warranted for 2 years. Any warranted part which is scheduled for replacement as required maintenance shall be warranted for the period of time up to the first scheduled replacement point for that part. **DIAGNOSIS:** The owner shall not be charged for diagnostic labor which leads to the determination that a warranted part is defective if the diagnostic work is performed at an approved **POULAN/WEED EATER** servicing center. **CONSEQUENTIAL DAMAGES:** **POULAN/WEED EATER** may be liable for damages to other engine components caused by the failure of a warranted part still under warranty. **WHAT IS NOT COVERED:** All failures caused by abuse, neglect, or improper maintenance are not covered. **ADD-ON OR MODIFIED PARTS:** The use of add-on or modified parts can be grounds for disallowing a warranty claim. **POULAN/WEED EATER** is not liable to cover failures of warranted parts caused by the use of add-on or modified parts. **HOW TO FILE A CLAIM:** If you have any questions regarding your warranty rights and responsibilities, you should contact your nearest authorized service center or call **POULAN/WEED EATER** at **1-800-554-6723**. **WHERE TO GET WARRANTY SERVICE:** Warranty services or repairs shall be provided at all **POULAN/WEED EATER** service centers. call: **1-800-554-6723**. **MAINTENANCE, REPLACEMENT AND REPAIR OF EMISSION RELATED PARTS:** Any **POULAN/WEED EATER** approved replacement part used in the performance of any warranty maintenance or repair on emission related parts will be provided without charge to the owner if the part is under warranty. **EMISSION CONTROL WARRANTY PARTS LIST:** Carburetor, Ignition System: Spark Plug (covered up to maintenance schedule), Ignition Module. **MAINTENANCE STATEMENT:** The owner is responsible for the performance of all required maintenance as defined in the owner's manual.

---

The information on the product label indicates which standard your engine is certified.  
Example: (Year) EPA Phase 1 or Phase 2 and/or CALIFORNIA.

